

RAISCUBETM

DESKTOP 3D PRINTER

— USER MANUAL —

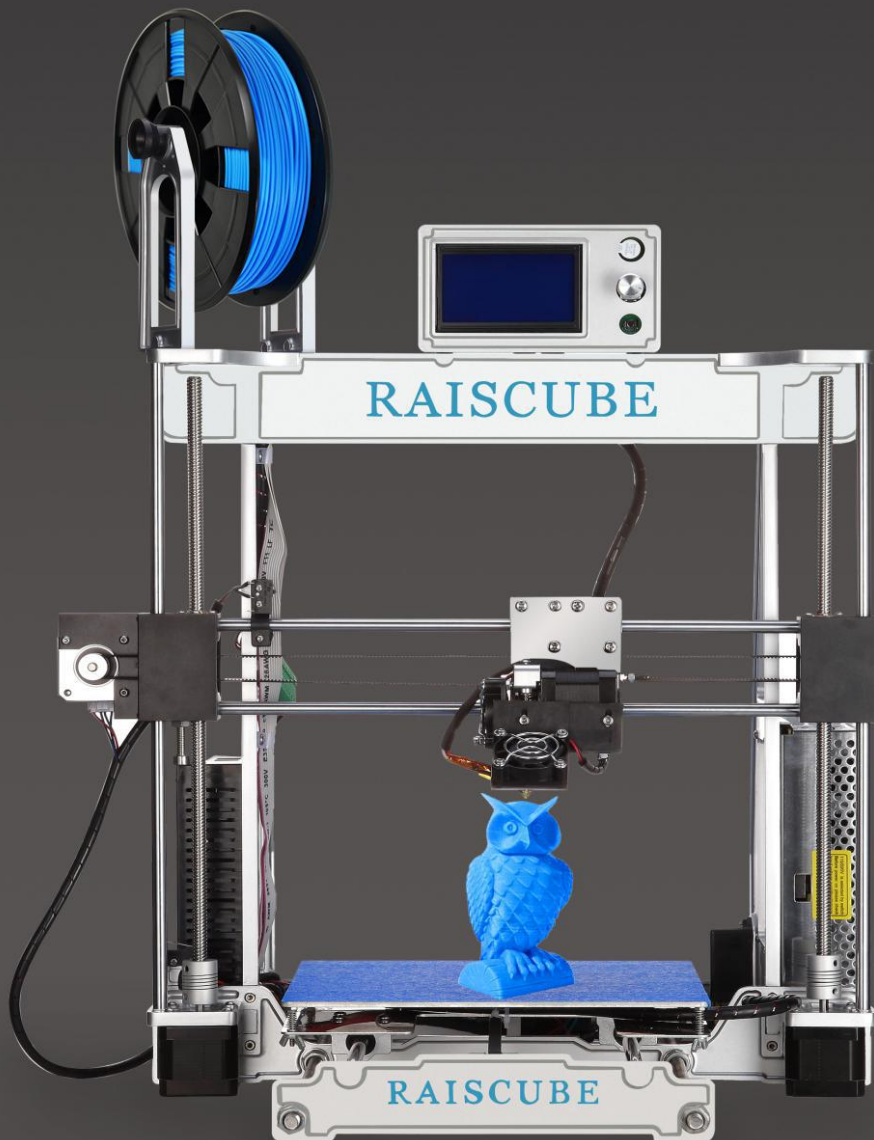

LEGAL NOTICE

PRODUCT WARRANTY

The RAISCUBE A8R 3D Printer is covered by a limited warranty.

OVERALL PROVISIONS

All information in this user manual (“Manual”) is subject to change at any time without notice and is provided for convenience purposes only. Shenzhen Ruisizhizao Technology CO.,LTD and our respective affiliates and suppliers (“Raiscube”) reserves the right to modify or revise this Manual in its sole discretion and at any time and makes no commitment to provide any such changes, updates, enhancements, or other additions to this Manual in a timely manner or at all. You agree to be bound by any modifications and/or revisions. Contact the Raiscube Support Team for up-to-date information. In order to protect Raiscube proprietary and confidential information and/or trade secrets, this document may describe some aspects of Raiscube technology in generalized terms.

DISCLAIMERS

Raiscube does not warrant the accuracy or completeness of the information, products, or services provided by or through this Manual and assumes no responsibility for any typographical, technical, or other inaccuracies in this Manual, which is provided “as is” and without any express or implied warranties of any kind, including warranties of merchantability, fitness for a particular purpose, or non-infringement of intellectual property. In connection with your use of this Manual, Raiscube shall not be liable to you for any damages whatsoever, be they direct, economic, commercial, special, consequential, incidental, exemplary, or indirect damages, even if Raiscube has been advised of the possibility of such damages, including without limitation, loss of business revenue or earnings, lost data, or lost profits. Raiscube assumes no responsibility, nor will be liable, for any damages to, or any viruses or malware that may infect, your computer, telecommunication equipment, or other property caused by or arising from your downloading of any information or materials related to this Manual. The foregoing exclusions do not apply to the extent prohibited by law; please refer to your local laws for any such prohibitions. Raiscube makes no warranties to those defined as “consumers” in the Magnuson-Moss Warranty-Federal Trade Commission Improvement Act.

INTELLECTUAL PROPERTY

Certain trademarks, trade names, service marks, and logos (the “Marks”) used in this Manual are registered and unregistered trademarks, trade names, and service marks of Raiscube and its affiliates. Nothing contained in this Manual grants or should be construed as granting, by implication, estoppel, or otherwise, any license or right to use any Marks without the written permission of Raiscube. Any unauthorized use of any information, materials, or Marks may violate copyright laws, trademark laws, laws of privacy and publicity, and/or other laws and regulations. Other company and/or product names mentioned herein may be trademarks of their respective companies.

© 2009-2016 Raiscube Industries, LLC. All rights reserved.

SAFETY AND COMPLIANCE

MANUFACTURER

Shenzhen Ruisizhizao Technology CO.,LTD
Floor 3, NO.18, Yaohui Industrial Park,
Dakan Industry Second Road,
Xili Street, Nanshan District,
Shenzhen, China. 518000.













RADIO AND TELEVISION INTERFERENCE

This equipment has been tested and found to comply with the limits for a Class B digital device, pursuant to Part 15 of the Federal Communications Commission (FCC) rules. These limits are designed to provide reasonable protection against harmful interference in a residential installation. This equipment generates, uses and can radiate radio frequency energy and, if not installed and used in accordance with the instructions, may cause harmful interference to radio communications. However, there is no guarantee that interference will not occur in a particular installation. If this equipment does cause harmful interference to radio or television reception, which can be determined by turning the equipment off and on, the user is encouraged to try to correct the interference by one or more of the following measures:

- Reorient or relocate the machine.
- Increase the separation between the equipment.
- Connect the equipment to an outlet on a different circuit.

Any changes or modifications made to this equipment voids your authority to operate this equipment under FCC Rules.

Precautions

-  Warning: The printer can only be used with original power supply, or the product may be damaged, with a risk of fire.
-  Warning: The RAISCUBE A8R generates high temperatures. To avoid burning, or model deformation, do not touch the model, nozzle, or the platform by hand, or any other part of the body, while the printer is working or immediately after it has finished printing.
-  Warning: There is a slight smell from ABS when it is being extruded. The smell is, however, not too unpleasant. Operate in a well ventilated room but draught free. Draught can affect warping of ABS prints. When ABS is burnt is releases toxic fumes.
-  Warning: Do not use ABS plastic or its printed parts near any kind of heat source, flames, fireworks, candles, light bulbs, etc. ABS will catch fire and burn a thick black smoke.
-  Warning: Always have adult supervision when children are present. Please keep all small printed parts away from young children, choking hazards! There are several safety issues, small tools, sharp tools and HOT objects and most parts used in connection with the 3D Printer. Tie back long hair and loose clothing. Keep fingers away from moving parts.
-  Warning: Tools and parts should be stored at a suitable height away from small children.
-  Caution: The socket outlet must be located near the equipment and must be easily accessible.
-  Caution: In case of emergency disconnect the RAISCUBE A8R from the wall socket.
-  Caution: The RAISCUBE A8R melts plastic during printing. Plastic odors are emitted during this operation. Make sure to set up the RAISCUBE A8R in a well-ventilated area.
-  Warning: Do not leave the RAISCUBE A8R unattended during operation.

Build Instruction of Raiscube A8R 3D Printer

Simply we can divide A8R into four segments – Frame, Build Platform, X&Z Motion, and circuit. We are going to build it one by one in order. Therefore, four major steps to go completing it, taking 1-3 hours from package to make it on in right way.

Ahead of building, get all parts including tools and screws out of box (Please refer to its packing list for all parts), and check all if any damage exists, especially the wires and their connectors. And **Switch PSU to the correct position according to the voltage in your country. E.g: 110V for US, 220V for UK.**

STEP ONE, FRAME BUILD. Build Aluminum frame first and add remains to it in next three steps.

First step, We need, left frame module, right frame module, Z Axis Stepper (R&L), Y Axis Stepper, frame crossbeam, middle bottom plate, back plate, M3 Hex Key Wrench, and 18pcs of M3*10 Socket Cap Screws. Please pick them from A8R package refer to Fig.b01.



Fig.b01

STEP 1-1 Connect Z Axis Stepper (R&L) middle bottom plate, please differentiate Left stepper from right stepper by the sideways hole as in Fig.b02, and we will get as in Fig.b03. Here we we need 4 pcs of M3*10 Socket Cap Screws, 2pcs each side.

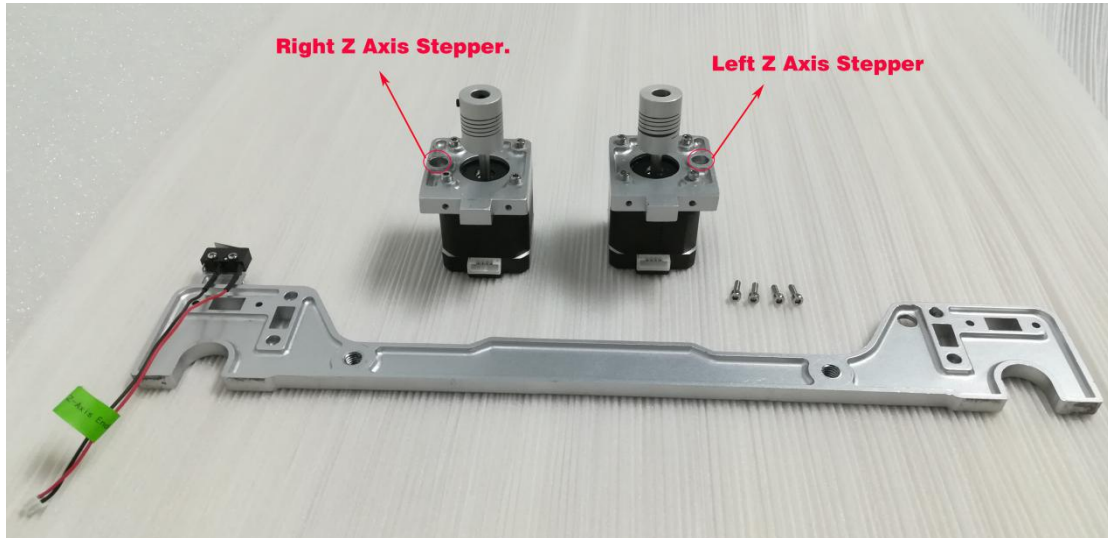

Fig.b02



Fig.b03

STEP 1-2 Connect “Left Frame Module” & “Right Frame Module” & what done in Step 1-1 (Fig.b03) together by 4 pcs of M3*10 Socket Cap Screws, 2pcs each side. Please check Fig.b04, and we got what as in Fig.b05.



Fig.b04

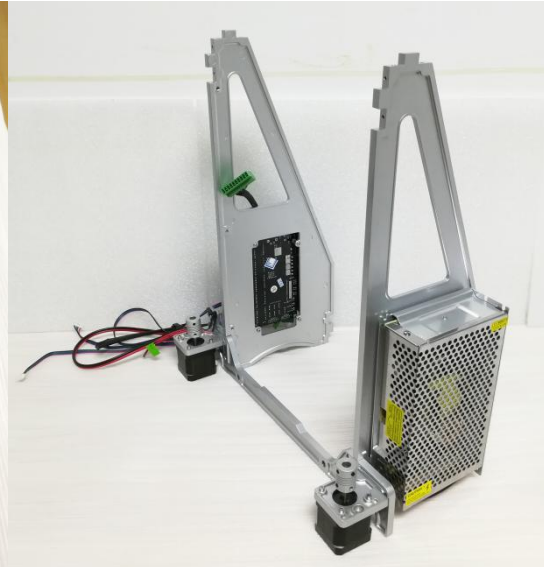

Fig.b05

STEP 1-3 Pick out “Back Plate” “Y Axis Stepper” and 2pcs of “M3*10 Socket Cap Screws”, let “Y Axis Stepper” join “Back Plate” using the screws. Please refer to Fig.b06 and Fig.b07 for this substep.



Fig.b06

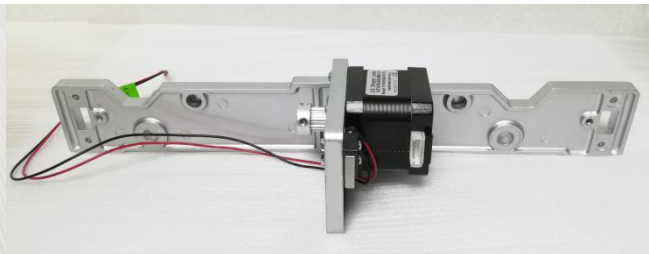

Fig.b07

STEP 1-4: Add what done in step 1-3 to the main frame which was done in step 1-2, and fasten them by 4pcs of M3*10 socket cap screws. From Fig.b08 to Fig.b09, it illustrates how is this going.

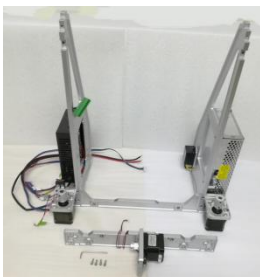

Fig.b08

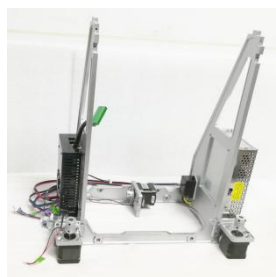

Fig.b09

STEP 1-5: Add crossbeam. Find “Frame Crossbeam” in the package and also 4pcs of M3*10 Socket Cap Screws, connect it to main frame as in Fig.b10 and Fig.b11. Now we have finished building A8R frame. Double check it again to make sure everything in the right way as in pictures. Afterwards, time to move to next major step – Build Platform assembly.



Fig.b10

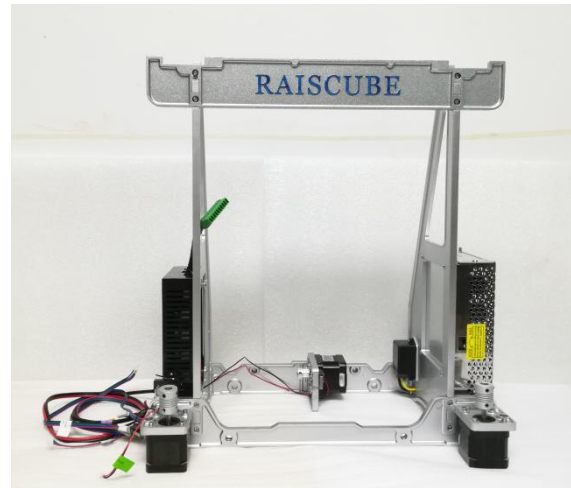

Fig.b11

STEP TWO – “Build Platform” assembly.

“Build Platform” is a function module including “hotbed” and its “H” support plate”, 2pcs of 420mm threaded rods, 2pcs of 390mm rods, front plate, a belt, and 12pcs M8 nuts, 12sets of M8 Nut-Spacer-washer, to install these we need 2pcs of M8 wrench, and 2pcs of zip-tie. Please refer to Fig.b12 and “Packing List” to pick all these elements out.

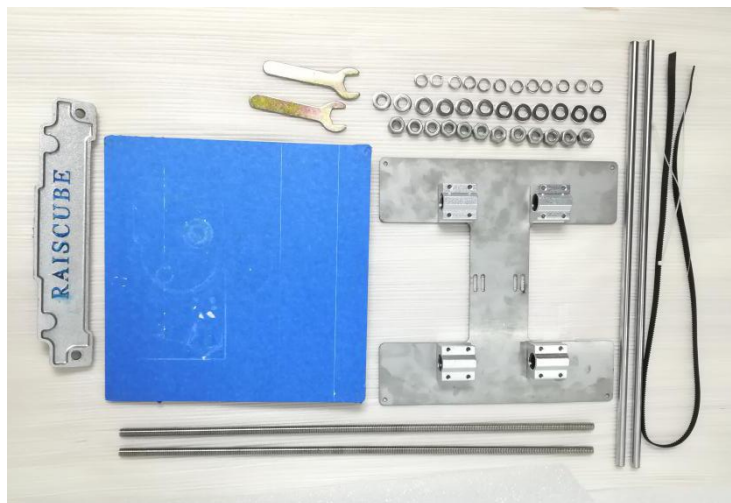

Fig.b12

“Build Platform” includes three layers, first layer is at the bottom made by two pcs of 420mm threaded rod along with 6 pairs of nut sets, which across back plate, middle plate, and front plate, and each plate is locked by two pairs of M8 Nut set along the threaded rods, each pair of nuts set on both sides of each plate. Second layer is the moving system, includes Y Axis stepper, Belt, belt bearing behind front plate, 390mm rods, (which go through four linear bearings beneath “H” plate, cross over middle plate and heads covered by holes of front and back plate), “H” module. And hotbed on the top for third layer. These three layers are combined together to form a movable “Build Platform”. In brief, what got to do is to turn Fig.b13 into Fig.b14.

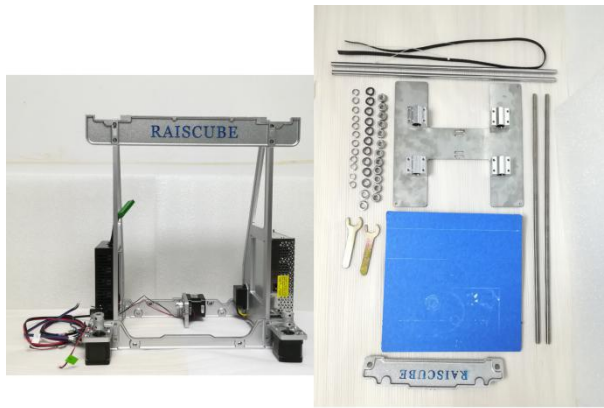

Fig.b13

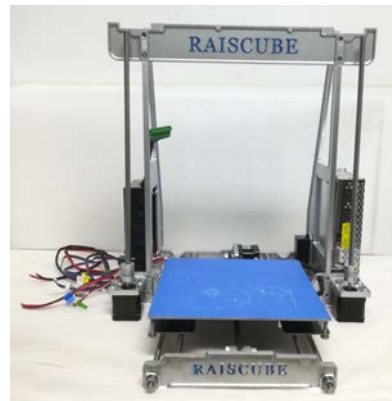

Fig.b14

Layer by layer, simply we divide STEP TWO into four substeps, well why not three, we need to connect double Z threaded rods to both Z Steppers respectively. preparation for STEP THREE.

STEP 2-1: Fasten 420 threaded rods to the frame with 4 pairs of M8 nut set. One pair of each hole point, two pairs of each plate. Here we need two M8 wrenches, 4 pairs of M8 Nut sets, and two pcs of 420mm threaded rods. Please refer to “video demo” in SD Card to get details of how to stack nut set and how to place each nut set along threaded rods.

Following Fig.b15, Fig.b16 show what looks like before and after this substep.

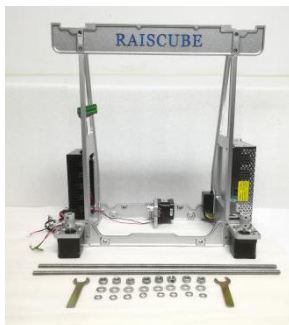

Fig.b15

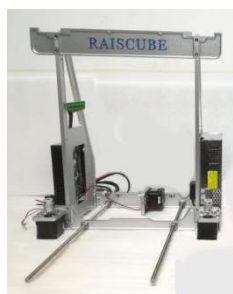

Fig.b16

STEP 2-2: Complete installation of second layer of “build platform”. To make sure it move smoothly, we need to insert rods through four linear bearings, and test if “H” module runs well on 390mm rod rail. If not, adjust screws which fasten linear bearings and “H” plate until it is. Fig.b17 and Fig.b18 are offered to help understand these actions. Let’s call this “H Train”.

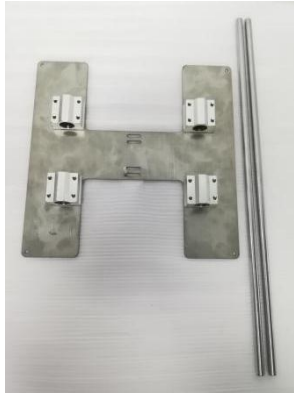

Fig.b17



Fig.b18

Coming after is to integrate “H train”, front plate, and belt into printer frame. Please see Fig.b19 and get ready of these. And then place “H train” over middle plate and bury rods’ heads into back plate, and screw 4cm distance of M8 Nut set (spacer facing front plate) along 420mm threaded rods, add front plate to rods and lock them with threaded rods by two more nut sets. Adjust nuts on threaded rod and front plate to cover 390mm rods. Insert belt through Y support rack behind front plate, one head attach to “H” plate, the other mount on synchronizing pulley and then attach to “H” plate. Please refer to Fig.b21 of how to attach belt to “H” plate. Then Fig.b20 is what when done so far.



Fig.b19



Fig.b20

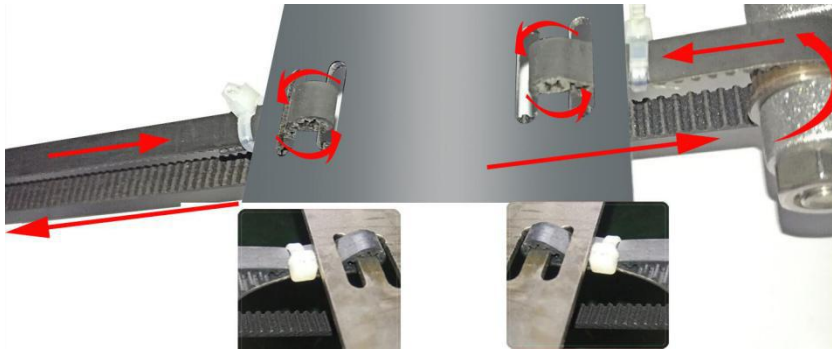

Fig.b21

STEP 2-3: Add Hotbed. We need hotbed plate(1pc), M3*25 screw (4pcs), M3 nut (4pcs) as in Fig.b21. M3*25 screws insert from upper side and lock it with M3 nut from the other side. We get in Fig.b22 when done here. And then, place hotbed over “H” plate, springs along each screw and press down through holes against “H” plate, lock each screw from downside with Knurl Nut. Please refer to Fig.b23 and Fig.b24 when doing.

PS: Heat bed power cord shall be on right (to connect to controller) when installed.

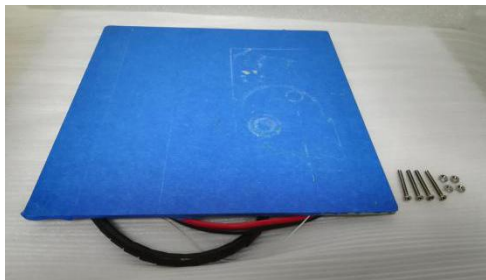

Fig.b21



Fig.22

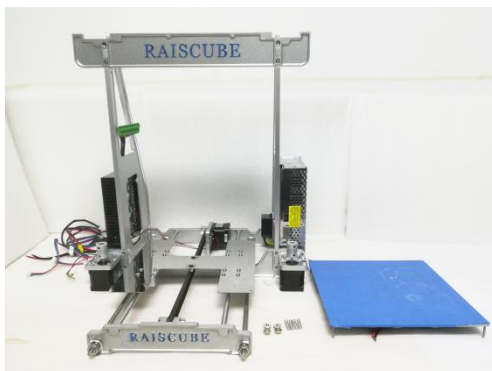

Fig.b23

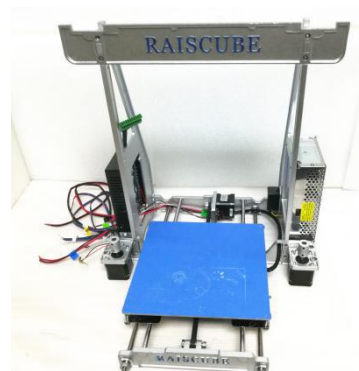

Fig.b24

STEP 2-4: Connect 2pcs of 350mm threaded rods to “Flexible Couple” on Z steppers and tighten them by driving set screws. (Fig.b25 to Fig.b26) Please note that there shall be 1-3mm free space between motor shaft and 350 threaded rods. (Fig.b27)

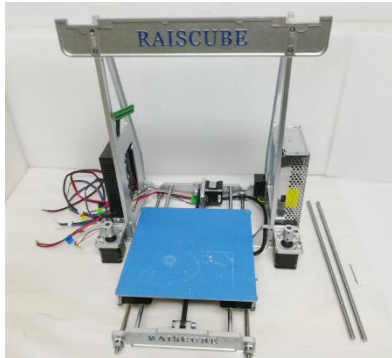

Fig.b25

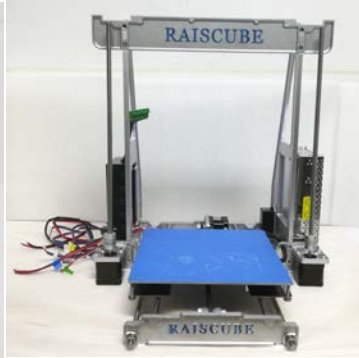

Fig.b26

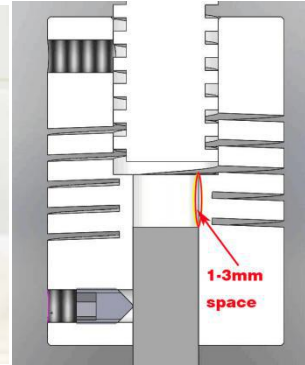

Fig.b27

STEP THREE. X&Z motion part installation.

Now in this step, time to enable motion function of X Axis and Z Axis. Here is a part list required to complete this step and there are as in Fig.b28, please pick out them all from packing box. When Step 3 all done, will be as in Fig.b29.

1. Extruder Module. -- 1pc
2. Left Link Block. -- 1pc
3. Right Link Block.(including M8*15 Set screw and its washer) -- 1pc
4. 350mm rod. -- 2pcs
5. Top Lock plate. -- 1 pair.
6. Filament Rack -- 1 pair.
7. M3*10 socket cap screws and hex key.
8. Belt 1pc
9. Zip-tie 2pcs
10. Control Panel Cable 2pcs
11. Hex Wrench 2pcs
12. Control Panel



Fig.b28

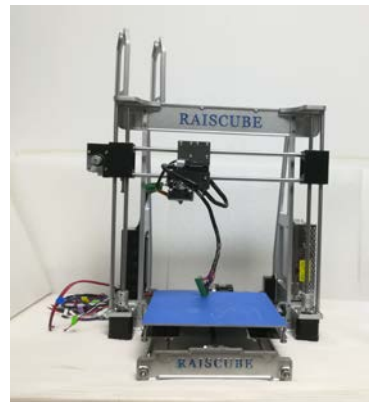

Fig.b29

STEP 3-1,

Connect Left link block, extruder module, and right link block one by one together by 350mm rod, check if extruder module is free to run on rod rail backwards and forwards. Then, we get "X Axis module" ready to integrating into main machine body. Fig.b30 and Fig.b31 for this substep.

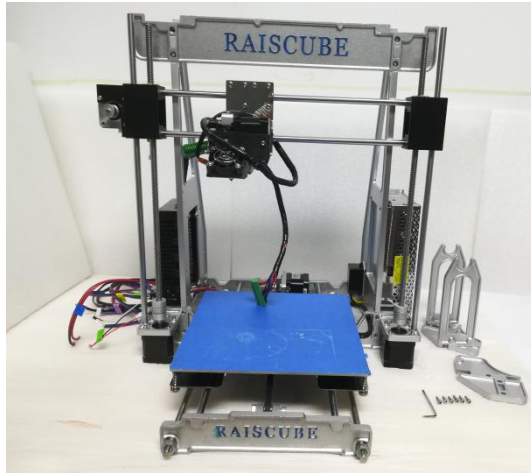

Fig.b34

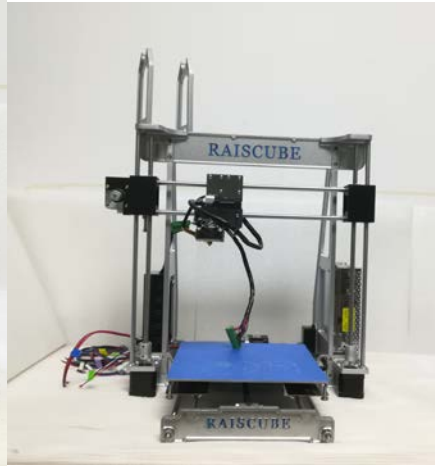

Fig.35

STEP 3-4 Add Control Panel.

We need panel control, allen key, two M3*12 Screw (Fig.b36). Connect it to Crossbeam behind (Fig.b37).

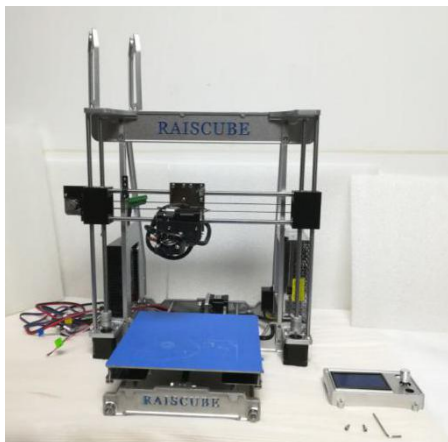

Fig.b36

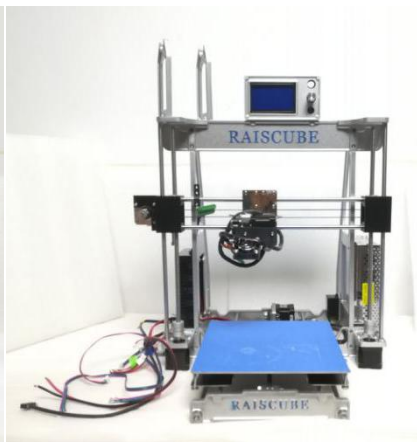

Fig.b37

STEP 3-5 X Axis Belt, X end-stop, M8*15 Set screws.

- A. Same as Y-belt, mount X-Belt on left&right block, and zip-tie to extruder from both sides.(Fig.38)
- B. Get X end-stop with its support from motherboard module, and place its support on upper left rod, move to the location where stop extruder moving left when nozzle on left edge of hotbed. (Fig.b39)
- C. Together with M8*15 set screw there are two ABS spacers too. Insert into two hole on right side of right link block, and drive M8*15 set screws to tighten rods. (Fig.b40)

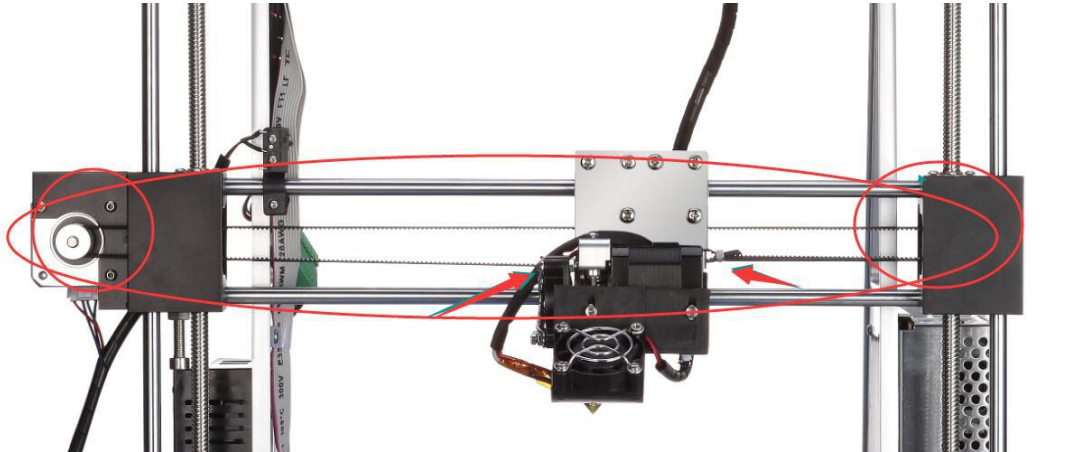

Fig.b38

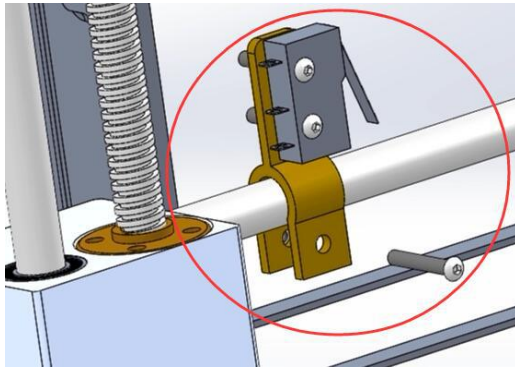

Fig. b39

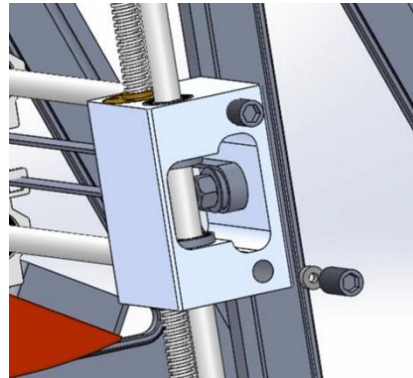

Fig.b40

So far, we have done the build structure of RAISCUBE A8R 3D Printer. One thing remaining before printing -- Circuit Installation. Let's go for step 4.

STEP FOUR

What remaining is circuit connection, including end-stops. There are several wire terminals to connect to its matching terminal one by one. Please refer to the marks to make it easier. Please note that it is required to install X Axis end-stop at this step two. Please locate "X end-stop support" on left of upper rod, where its switch get triggered when Nozzle just reaches left margin of hotbed.

A8R wire is pre-assembled, thus to connect circuit, need to read marks on each cord, and match one with the other of same mark. For example, "Y Axis End-stop" with "Y Axis En-stop" as in Fig.w01. And Fig.w02 shows joints of connection between motherboard and other function modules in circuit.

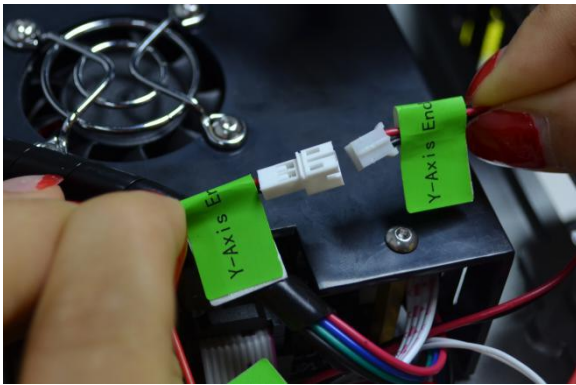

Fig.w01

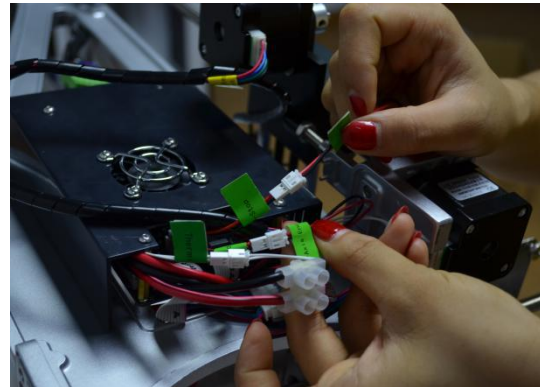

Fig.w02

Please also note that when connecting motherboard to power supply, there are one red, and one black cord piece. Red for "V+", Black for "COM". (Fig.w03). Please note that there is one more Red cord connecting to the PSU "V+" from Heat bed. *In fact, Heat bed Red cord ("+" go to PSU "V+", while Black Cord ("-") connect with the terminal from Main Board.(Fig.w03-h)*



Fig.w03



Fig.w03-h

Panel Cable Connection.

There are two panel cable, to connect ports of panel control with corresponding ports on motherboard, that is, "EXP1 to EXP1", "EXP2 to EXP2". Please refer to Fig.w04, Fig.w05 and Fig.w06 for this.

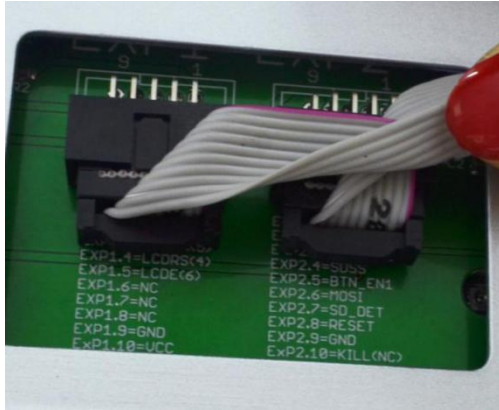

Fig.w04



Fig.w05

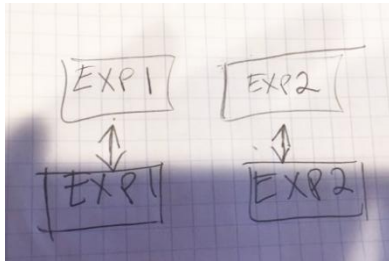

Fig.w06

For further details, please see our wire connect file in SD Card in carton, "Wire Connection.mp4".

Kind Reminder: To make wire path look well, and enable moving well, please pay attention to how the wire paths as are in Fig.w07&Fig.08.

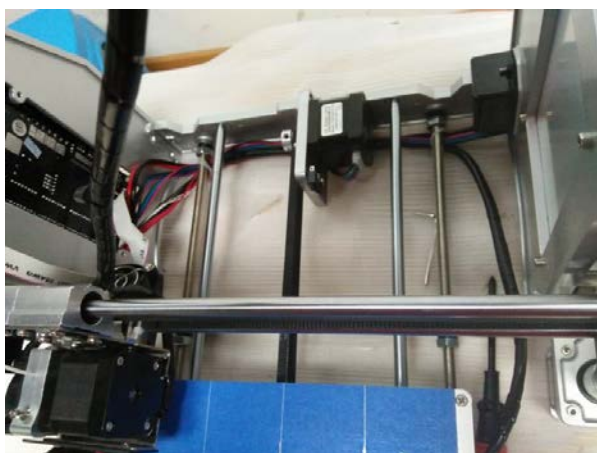

Fig.w07



Fig.w08

Now it is end of printer build. Connect the plug to socket nearby machine, and machine shall be on with “Ready” on screen. We go next steps for leveling and first printing.

A8R LEVELING

Bed Leveling is a basic skills required for FDM 3D printing. Because build platform leveling has a significant impact on printing quality. Bad work of leveling may leads to warping (lift), clogged nozzle, can not stick to bed, etc. Thus, it is worthwhile of spending time and patience on leveling. And you will also enjoy the benefits brought by A8R printer.

Bed Leveling includes two points -- the bottom surface of link blocks shall be parallel with hotbed surface, and the distances of nozzle summit to each point of bed shall be same under certain tolerance. Two main steps for leveling.

STEP ONE: Get a regular rectangle object, place it on either Z stepper, turn left and right flexible coupling to touch the object, and place same object in same position between Z stepper and link block, turn flexible coupling to make it reach up and down face just. Please refer to Fig.g01 and Fig.02 for this.

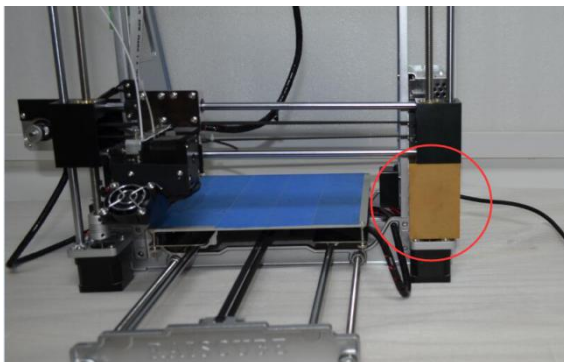

Fig.g01

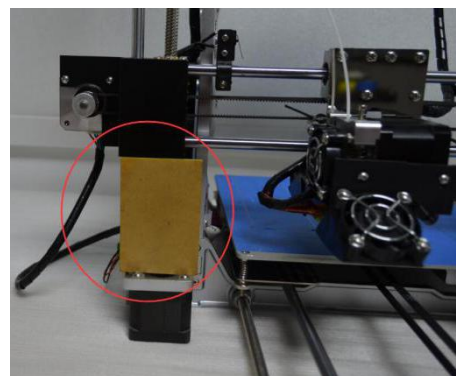

Fig.g02

STEP TWO: Even bed. We aim to make same distance of it between nozzle and bed in different positions. In our case, we make point of four corners to stand for all other positions. (It makes sense since bed is absolutely even made). Let's make sequences as "Front Left" -- "Front Right" -- "Back Right" -- "Back Left" and "Back Right" -- "Front Right" -- "Front Left".

There are two elements can be adjusted to even bed -- M6 screw under left link block and Hotbed Fastener Set. (Fig.g03 Left green circle is M6 screw, right green circle is "Hotbed Fastener Set").

Let's adjust first point -- Front Left. First, disable the Stepper motors in the LCD menu, so we can move the extruder and plate by hand to "Front Left". And use "Z home" order from LCD Screen, the M6 screw will hit Z axis End-stop switch by then. Now we check and adjust M6 screw to make the nozzle top just touch bed, or allow dragging a piece of A4 paper through.

Move extruder to "Front Right", and "Z Home" command from Panel control, check and adjust the thumbscrew under hotbed to make he nozzle top just touch bed, or allow dragging a piece of A4 paper through. Repeat this step in other point by sequence set above.

For further detailed information, please find on http://reprap.org/wiki/Leveling_the_Print_Bed .

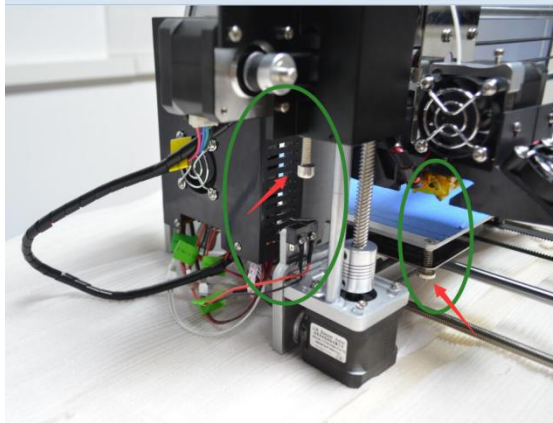

Fig.g03

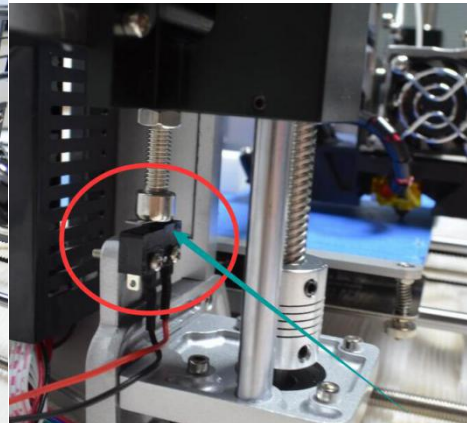

Fig.g04

PRINT TEST.

Whether it is well leveled or not, we need to test. To print a model and particular observe how the first few layers are stick to bed. If not good enough, we need to stop printing and check and adjust leveling again, or review and check other steps during full installation.

Further details of printing, let's go next to "sample print show".

Sample Print Show.

Since we have get A8R ready for printing after leveling, now go further steps to our first print.

Let's say steps are

1. Source file Acquirement
2. Slicing origin file with Cura, Simplified 3D or other slicing software.
3. Transfer sliced file to 3D Printer.
4. Print.
5. Remove prints.
6. Evaluate print quality.

Let's take an example to go through these steps.

Source file acquirement. Get ".stl" or ".object" design files from any design software (e.g freecad, pro-E, etc), or we can download online. In our case, we download one from <https://www.thingiverse.com/thing:1278865>. Extract "xyzCalibration_cube.stl" from download zip file. Now we have the ".stl" file. (Fig.s01)

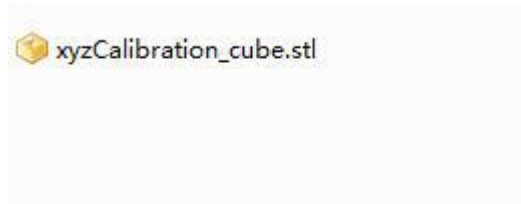
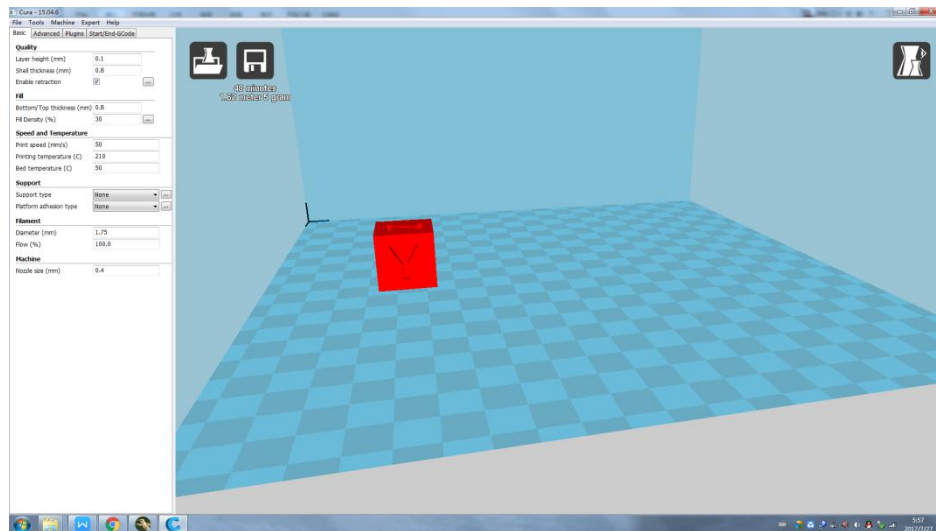

Fig.s01



Slicing: Load it to Cura software. Configure slicing parameters in Cura. (Fig.s02) If you have no Cura installed in your PC, please find it in the SD Card which in printer package, and install it step by step. You also refer to "Cura 15.04 installation guide.pdf" in SD Card file. Fig.s02

Transfer file to Print: “save GCode..” to SD Card. (Fig.s03)

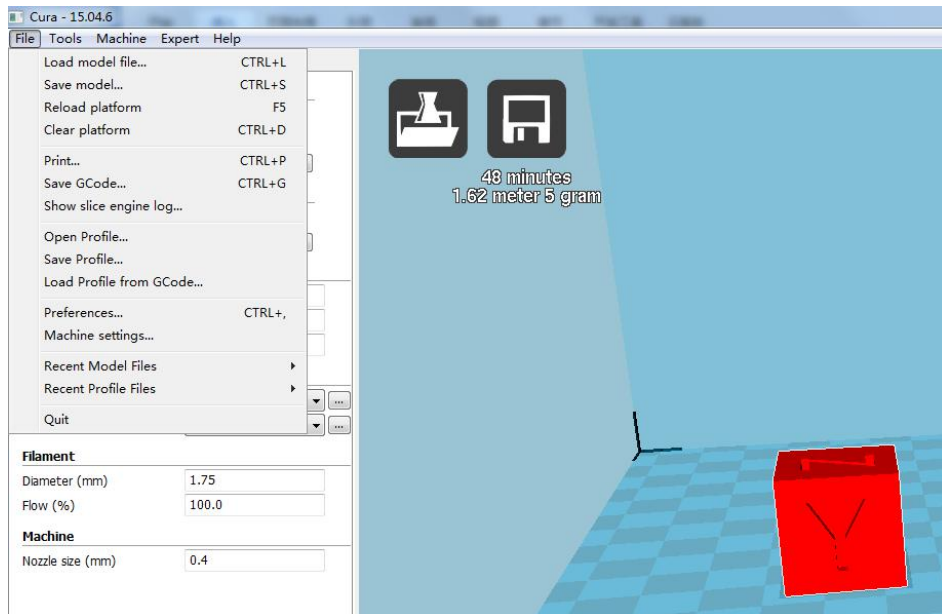

Fig.s03

Print: In 3D control panel, press and turn the control button to print from SD Card. “Main Menu” --- Print From SD Card --- xyzCalibration_cube.stl, choose this and printing screen on with info of current print. (Fig.s04)



Fig.s04

Remove print: When print done, Extruder will lift and go back to its origin (front left most point of hotbed). Use a spatula (enclosed in package) to move the cube. (Fig.s05)

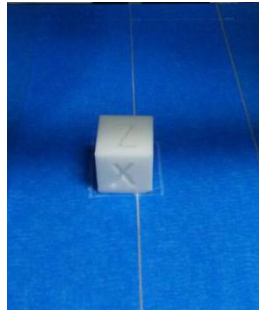

Fig.s05

Evaluate print quality: In our cases, warping happens due to leveling issue, adjust hotbed and solved. A regular cube model is printed. When measure its dimension, it should be 20*20*20mm, our print is 20.08*20.02*20.04mm. (Fig.s06, Fig.s07)



Fig.s06



Fig.s07

Resource List for you may help

Reprap Facebook Group: <https://www.facebook.com/groups/1068531466501015>

Youtube Installation Demo: <https://youtu.be/oJS6ODX52ng>

Youtube Build Video: <https://youtu.be/OweEknLShZ0>

Raiscube A8R Live Build: <https://youtu.be/C2Oinymgclg>

Designed in UK&US, Manufactured By Shenzhen Rise Technology CO.,LTD